

DR8; 3-Circuit Track LED 6° Optic 24W

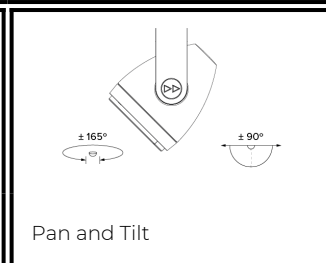
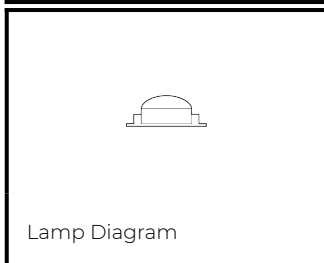
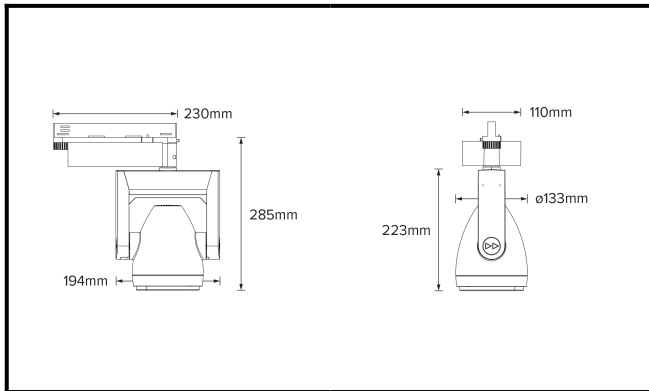

PHYSICAL	MOUNTING:	3-Circuit Track
	WEIGHT:	1.97kg
	FINISH:	White RAL9010
	MAX AMBIENT TEMPERATURE:	40°C
	CEILING CLEARANCE:	N/A
	CEILING CUT-OUT:	N/A
	CEILING THICKNESS:	N/A
CONTROL	MOVEMENT TYPE:	Handheld Remote
	DIMMING OPTION:	DALI Dimming

SPECIFICATION DR8 3000K LED (20W for light source) spotlight for 3-Circuit Eutrac with 6° optic. Manufactured from LM24 aluminium and glass-filled polycarbonate. Finished in white (RAL 9010). Voltage is 220-240V 50/60HZ. Luminaire has high-performance colour rendering of 90+ CRI. Luminaire can be rotated, with +/- 165° movement through the pan axis and +/- 90° through the tilt axis, at a resolution of less than 1° in either axis. Movement is controlled using a handheld remote, and dimming is controlled using external DALI dimming. Recording and recall of luminaire position (pan and tilt) with handheld remote controller as standard.

PART NO.

DR8.0015

PRODUCT SUMMARY

DR8 Spotlight; 220-240V 50/60Hz; 3~ Eutrac; 6° Optic; 3000K 90+CRI LED 20W; White; Movement using Handheld Remote; Dimming Using External DALI Control

DR8; 3-Circuit Track LED 6° Optic 24W

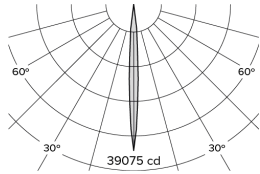

Photometry

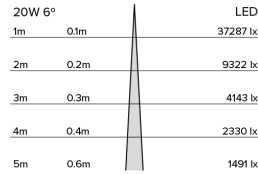

Cone Diagram

MOVEMENT	MOVEMENT TYPE:	Handheld Remote
	PAN MOVEMENT RANGE:	±165°
	TILT MOVEMENT RANGE:	±90°
	PAN MOVEMENT RESOLUTION:	<1°
	TILT MOVEMENT RESOLUTION:	±90°
	PAN SPEED OF MOVEMENT:	23°/s
	TILT SPEED OF MOVEMENT:	16°/s

LIGHTING	LIGHT SOURCE:	LED
	MIN. DISTANCE FROM TARGET:	N/A
	MODULE LUMEN OUTPUT:	1300lm
	ABSOLUTE LUMEN OUTPUT:	1100lm
	GLARE MECHANICAL CUT-OFF:	22°
	GLARE COMFORT CUT-OFF:	50°
	COLOUR TEMP:	3000K

ELECTRICAL	VOLTAGE REGION:	220 - 240V 50/60Hz
	IEC PROTECTION CLASS:	Class 1
	LIGHT SOURCE WATTAGE:	20W
	MOVEMENT WATTAGE:	4W
	LUMINAIRE CIRCUIT WATTAGE:	24W

PART NO.

DR8.0015

PRODUCT SUMMARY

DR8 Spotlight; 220-240V 50/60Hz; 3~ Eutrac; 6° Optic; 3000K 90+CRI LED 20W; White; Movement using Handheld Remote; Dimming Using External DALI Control