

DR8; 3-Circuit Track LED 10° Optic 24W

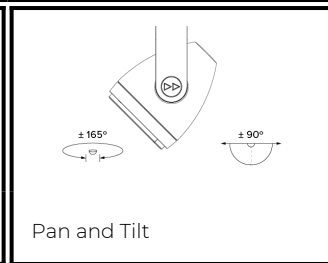
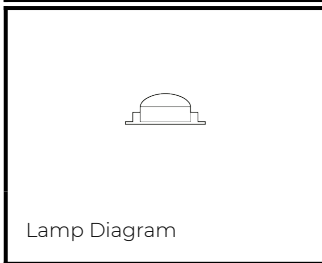
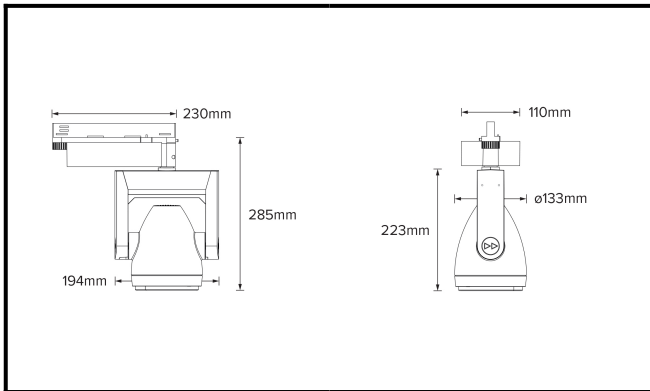

PHYSICAL	MOUNTING:	3-Circuit Track
	WEIGHT:	1.97kg
	FINISH:	White RAL9010
	MAX AMBIENT TEMPERATURE:	40°C
	CEILING CLEARANCE:	N/A
	CEILING CUT-OUT:	N/A
	CEILING THICKNESS:	N/A

CONTROL	MOVEMENT TYPE:	Handheld Remote
	DIMMING OPTION:	DMX

SPECIFICATION DR8 3000K LED (20W for light source) spotlight for 3-Circuit Eutrac with 10° optic. Manufactured from LM24 aluminium and glass-filled polycarbonate. Finished in white (RAL 9010). Voltage is 220-240V 50/60HZ. Luminaire has high-performance colour rendering of 90+ CRI. Luminaire can be rotated, with +/- 165° movement through the pan axis and +/- 90° through the tilt axis, at a resolution of less than 1° in either axis. Movement is controlled using a handheld remote, and dimming is controlled using DMX. Recording and recalling of scenes as standard.

PART NO.

DR8.0030
PRODUCT SUMMARY

DR8 Spotlight; 220-240V 50/60Hz; 3~ Eutrac; 10° Optic; 3000K 90+CRI LED 20W; White; Movement using Handheld Remote; Dimming using DMX Control

DR8; 3-Circuit Track LED 10° Optic 24W

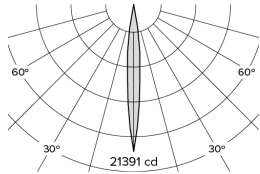

Photometry

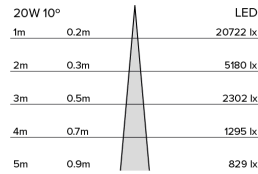

Cone Diagram

MOVEMENT	MOVEMENT TYPE:	Handheld Remote
	PAN MOVEMENT RANGE:	±165°
	TILT MOVEMENT RANGE:	±90°
	PAN MOVEMENT RESOLUTION:	<1°
	TILT MOVEMENT RESOLUTION:	±90°
	PAN SPEED OF MOVEMENT:	23°/s
	TILT SPEED OF MOVEMENT:	16°/s

LIGHTING	LIGHT SOURCE:	LED
	MIN. DISTANCE FROM TARGET:	N/A
	MODULE LUMEN OUTPUT:	1300lm
	ABSOLUTE LUMEN OUTPUT:	1100lm
	GLARE MECHANICAL CUT-OFF:	22°
	GLARE COMFORT CUT-OFF:	50°
	COLOUR TEMP:	3000K

ELECTRICAL	VOLTAGE REGION:	220 - 240V 50/60Hz
	IEC PROTECTION CLASS:	Class 1
	LIGHT SOURCE WATTAGE:	20W
	MOVEMENT WATTAGE:	4W
	LUMINAIRE CIRCUIT WATTAGE:	24W

PART NO.

DR8.0030

PRODUCT SUMMARY

DR8 Spotlight; 220-240V 50/60Hz; 3~ Eutrac; 10° Optic; 3000K 90+CRI LED 20W; White; Movement using Handheld Remote; Dimming using DMX Control