

## Installation Instructions

### Remote Controlled Spotlight Type DRX1

#### BEFORE YOU START

Read these instructions carefully. For the latest instructions on all our products see [www.rclighting.com/downloads](http://www.rclighting.com/downloads)

These instructions cover the following installation methods:

- A 3-Circuit Installation
- B 1-Circuit Installation
- C 2-Circuit Installation
- D Monopoint Installation
- E Accessory Change

If you have any difficulty installing this product please contact:

Remote Controlled Lighting Ltd (UK)  
42 Riverside Road, London SW17 0BA  
+44 (0) 20 8404 2400  
tech@rclighting.com

Remote Controlled Lighting Ltd (Asia)  
Unit 13, 8/F, Lai Sun Yuen Long Centre  
21-35 Wang Yip Street East,  
Yuen Long, Hong Kong  
T: +852 2310 9733  
F: +852 2310 9723  
asia\_sales@rclighting.com

#### Important Safety Information

READ INSTRUCTIONS CAREFULLY BEFORE USING THIS PRODUCT. SAVE INSTRUCTIONS FOR LATER REFERENCE.

##### PRODUCT IS NOT SUITABLE FOR PHASE DIMMING

Products must be installed by a suitably qualified professional only. Installations must conform to national installation codes and accident prevention regulations.

If using a track adaptor, ensure it is compatible with the track system installed. Failure to do so may result in danger of electric shock and damage to the product.

Ensure electrical rating shown on product label conforms to mains voltage supply.

Do not modify the product in any way. RCL accepts no responsibility for damage caused by modifying this product.

Product is rated IP20 unless otherwise stated. Install indoors only and away from damp or wet environments.

This symbol indicates the minimum distance to a lighted object and must be observed.

Caution, product will become hot in use. Allow to cool before touching.

Dispose of this product in accordance with WEEE or other national regulations.

Products marked with this symbol are compliant with Class 2 regulations.

## A 3-Circuit Track Installation

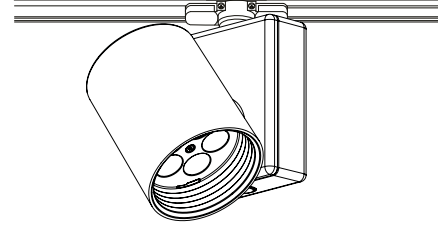

1 Ensure the track adaptor is compatible with the 3-Circuit track system installed. Unless otherwise specified, the DRX1 luminaire is supplied with a Eutrac 3-Circuit track adaptor as standard.

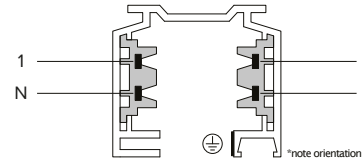

2 To mount the track adaptor into the track system, check that both tabs on the adaptor are in the open position and insert into the track.

#### NOTES

- Ensure the track adaptor is orientated correctly. Align the earthing tabs (A) with the slot (B) on the track.
- Allow a minimum of 300mm between luminaire mountings.

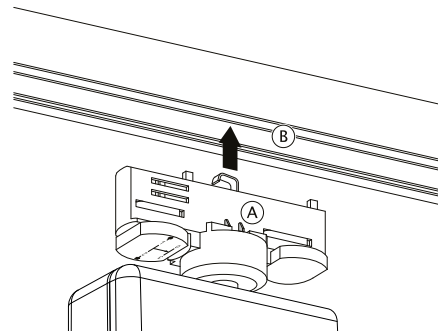

3 Rotate tab (C) clockwise 90° to connect the adaptor to the neutral circuit.

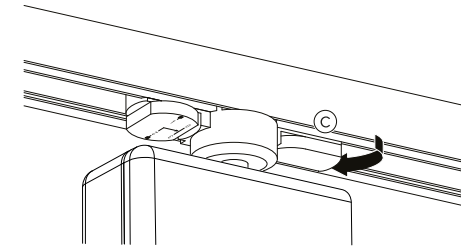

4 Rotate tab (D) to the desired circuit position (see section 5).

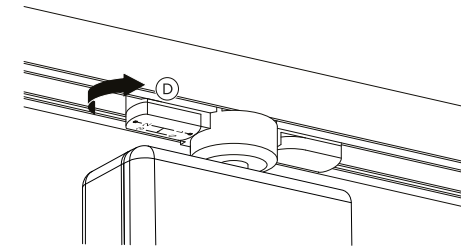

5 With the 3-Circuit track adaptor, you can choose which circuit the luminaire is connected to:

Unconnected - The luminaire is fixed to the track but not connected to any circuit.

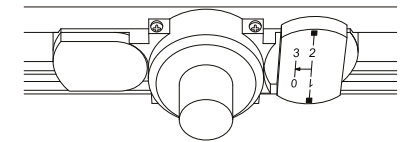

Circuit 1 - From the starting position, rotate the tab clockwise 90°.

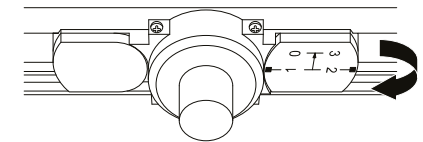

- 6 Circuit 2 - From the starting position, rotate the tab anti-clockwise 90°.

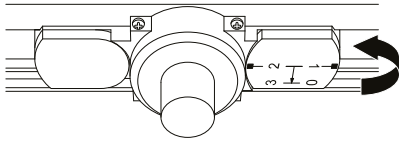

- Circuit 3 - From the starting position, pull tab down ① and rotate the tab anti-clockwise 90° ②.

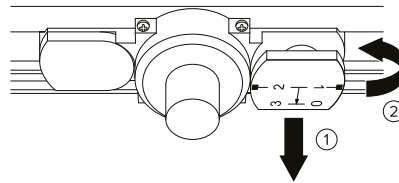

**NOTES**

- The Eutrac 3-Circuit track adaptor is compatible with a number of different 3-Circuit track systems including Eutrac, Erco & iGuzzini systems. For further options, please contact RCL.

## B 1-Circuit Track Installation

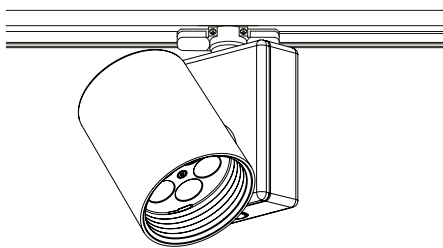

- 1 Ensure the track adaptor is compatible with the 1-Circuit track system installed. Unless otherwise specified, the DRX1 luminaire is supplied with a Eutrac 1-Circuit track adaptor as standard.

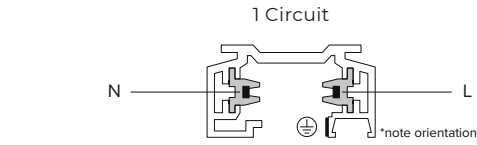

- 2 To mount the track adaptor into the track system, check that both tabs on the adaptor are in the open position and insert into the track.

**NOTES**

- Ensure the track adaptor is orientated correctly. Align the earthing tabs (A) with the slot (B) on the track.
- For multiple fixtures, allow a minimum of 300mm between luminaire mountings.

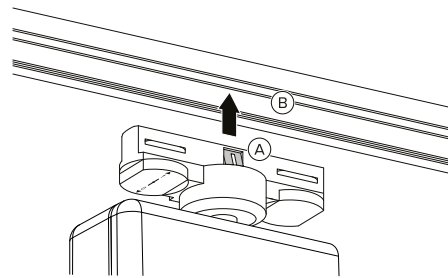

## C 2-Circuit Track Installation

- 1 Ensure the track adaptor is compatible with the 2-Circuit track system installed. Unless otherwise specified, the DRX1 luminaire is supplied with a Eutrac 2-Circuit track adaptor as standard.

To mount the track adaptor into the track system, check that both tabs on the adaptor are in the open position and insert into the track.

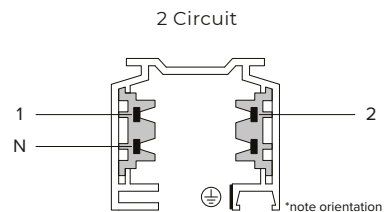

## D Monopoint Installation

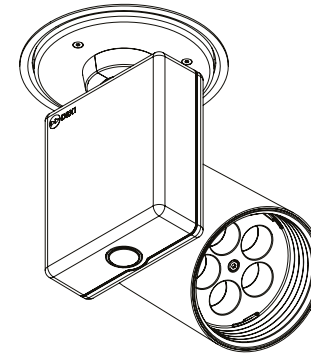

- 1 The monopoint fixture requires a minimum clearance distance of 200mm above and around the mounting point and a ceiling material thickness of 3-35mm.

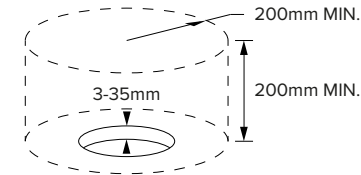

- 2 Mark up the ceiling and cut a circular hole 112-115mm in diameter.

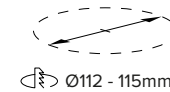

- 3 For multiple installations, ensure a minimum distance of 300mm between mounting points.



- 4 Insert the mounting ring into the hole so that it sits flush with the ceiling.

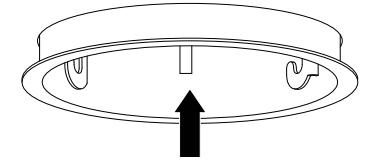

- 5 Holding the mounting ring in place, insert a fixing clip into a slot on the mounting ring.

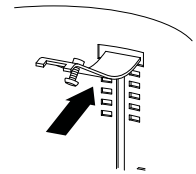

- 6 Slide the fixing clip down the slot until it hits the ceiling material.

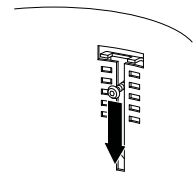

- 7 Insert fixing studs into mounting ring holes and, using a 2.5mm hex screwdriver, secure the clip in place. Repeat this process for each fixing clip.

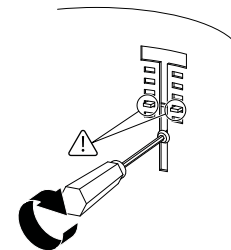

8 Ensure that the luminaire is securely installed, with the fixing clips firmly against the ceiling material.

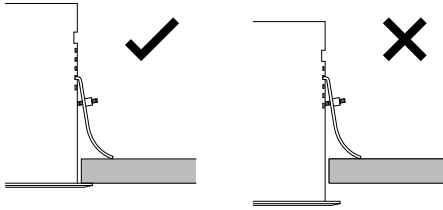

**⚠ WARNING**

- If for any reason the mounting ring cannot be fitted securely, stop the installation and contact RCL.

9 Run mains voltage cable to the hole and connect to the luminaire using an electrical connector (not supplied).

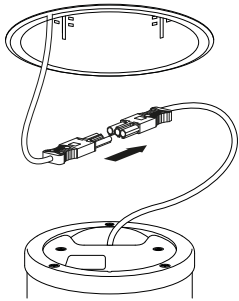

10 For projects that require DMX or DALI control, a 3-way connector will be present on the monopoint head.

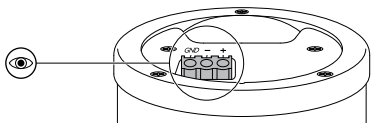

**✎ NOTES**

- For further instructions on DMX wiring and installation, please refer to DOC-083.
- DMX cable runs must be terminated using a 1W 120 Ω resistor that is connected to the last 3-way connector in the spotlight chain.

11 If DMX or DALI control is specified, run appropriate cable to the mounting hole and connect to the monopoint head using the 3-way connector supplied.

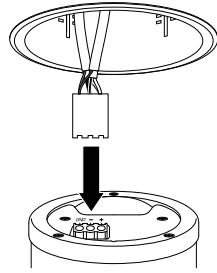

12 Insert the control gear through the mounting ring onto the upper surface of the ceiling.

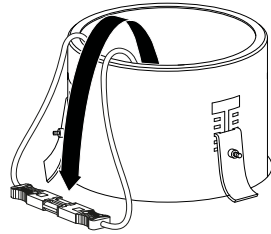

13 Insert DRX1 Monopoint head into mounting ring.

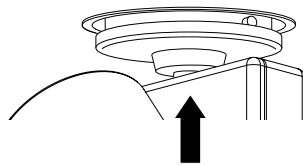

14 Twist spotlight clockwise and pull down gently to lock in place.

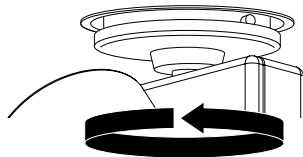

15 Ensure that the monopoint head studs locate securely in the mounting ring hooks, as shown below.

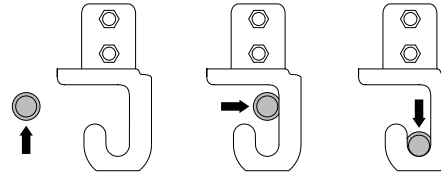

16 For multiple fixtures, Align primary hooks (denoted by a directional arrow) perpendicular to a feature such as a wall or trough edge to ensure all fixtures will align.

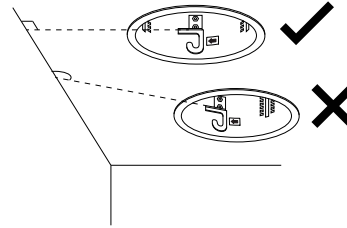

## E Accessory Change

1 DRX1 accessories work in conjunction with the MEC-660 Accessory Clip. To ensure that the accessory is safely held in place at all times, combine the accessory with the clip.

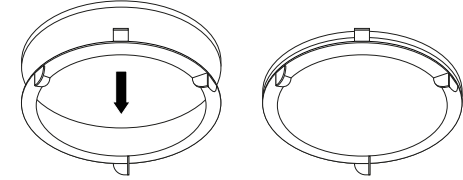

2 Using the finger grips on the outside of the clip, raise the accessory into the can of the DRX1 until it meets the LED module.

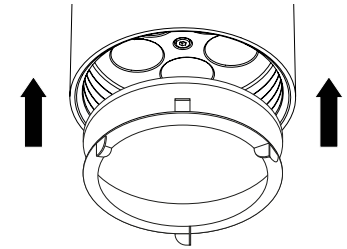

3 To hold the accessory clip safely in place, rotate it clockwise until it locks with the fitting.

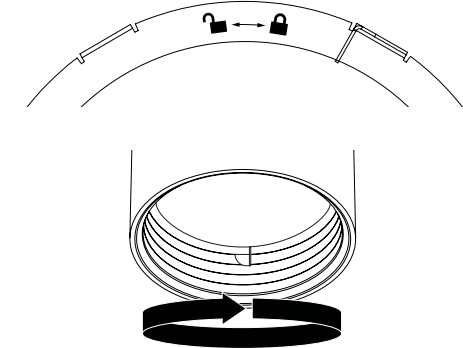



If you have any difficulty installing this product please contact:

Remote Controlled Lighting Ltd (UK) | 42 Riverside Road, London SW17 0BA  
+44 (0) 20 8404 2400 | [tech@rclighting.com](mailto:tech@rclighting.com)

Remote Controlled Lighting Ltd (Asia) | Unit 13, 8/F, Lai Sun Yuen Long Centre  
21-35 Wang Yip Street East, Yuen Long, Hong Kong  
T: +852 2310 9733 | F: +852 2310 9723  
[asia\\_sales@rclighting.com](mailto:asia_sales@rclighting.com)