

Installation Instructions

Remote Controlled Spotlight Type DR7

BEFORE YOU START

Read these instructions carefully. For the latest instructions on all our products see www.rclighting.com/downloads

These instructions cover the following installation methods:

- A Mounting Ring Installation
- B Lamp Change - QR111
- C Accessory Change - QR111
- D Accessory Holder Installation

If you have any difficulty installing this product please contact:

Remote Controlled Lighting Ltd (UK)
42 Riverside Road, London SW17 0BA
+44 (0) 20 8404 2400
tech@rclighting.com

Remote Controlled Lighting Ltd (Asia)
Unit 13, 8/F, Lai Sun Yuen Long Centre
21-35 Wang Yip Street East,
Yuen Long, Hong Kong
T: +852 2310 9733
F: +852 2310 9723
asia_sales@rclighting.com

Important Safety Information

READ INSTRUCTIONS CAREFULLY BEFORE USING THIS PRODUCT. SAVE INSTRUCTIONS FOR LATER REFERENCE.

PRODUCT IS NOT SUITABLE FOR PHASE DIMMING

Products must be installed by a suitably qualified professional only. Installations must conform to national installation codes and accident prevention regulations.

If using a track adaptor, ensure it is compatible with the track system installed. Failure to do so may result in danger of electric shock and damage to the product.

Ensure electrical rating shown on product label conforms to mains voltage supply.

Do not modify the product in any way. RCL accepts no responsibility for damage caused by modifying this product.

Product is rated IP20 unless otherwise stated. Install indoors only and away from damp or wet environments.

This symbol indicates the minimum distance to a lighted object and must be observed.

Caution, product will become hot in use. Allow to cool before touching.

Dispose of this product in accordance with WEEE or other national regulations.

Products marked with this symbol are compliant with Class 2 regulations.

Mounting Ring Installation

Before you start, check that you have all the parts listed below. Only 1 part of either (B) or (C) should be included.

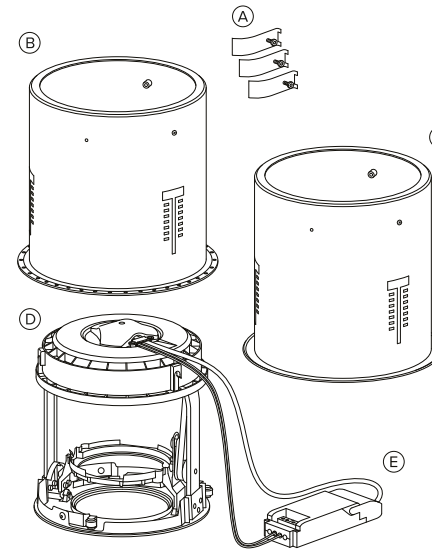

A - Fixing Clips (x3) B - Trimless Mounting Ring
C - Standard Mounting Ring D - DR7 Luminaire
E - Transformer

NOTES

- Transformer may differ from model shown above depending on voltage region.

The DR7 fixture requires a *minimum* clearance distance of 250mm above and around the mounting point and a ceiling material thickness of between 3-45mm.

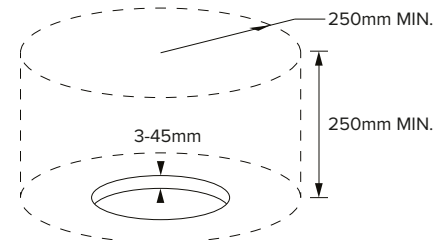

Mark up ceiling and cut a circular hole 195-200mm in diameter.

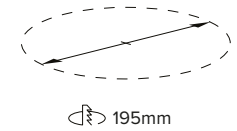

For multiple installations, ensure a *minimum* distance of 500mm between mounting points.

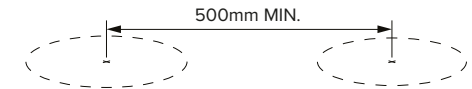

Insert the mounting ring into the hole and push up so that it sits flush with the ceiling.

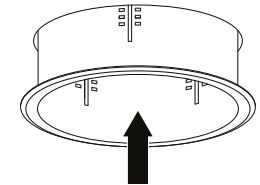

Holding the mounting ring in place, insert a fixing clip into a slot on the mounting ring, then slide it down the slot until it hits the ceiling material.

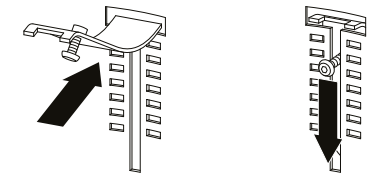

These guidelines can be used to determine the most appropriate slots to use for varying ceiling thicknesses.

	← 40-45mm thickness
	← 33-40mm thickness
	← 27-33mm thickness
	← 21-27mm thickness
	← 15-21mm thickness
	← 9-15mm thickness
	← 3-9mm thickness

- 8 Insert fixing studs into mounting ring holes and, using a 2.5mm hex screwdriver, secure the clip in place. Repeat this process for each fixing clip.

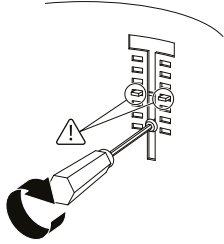

- 9 Ensure that the luminaire is securely installed, with the fixing clips firmly against the ceiling material.

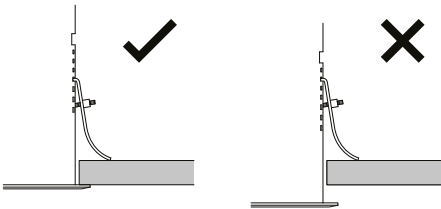

⚠ WARNING

- If for any reason the mounting ring cannot be fitted securely, stop the installation and contact RCL.

- 10 For DR7 Trimless variants, plaster and paint the ceiling, including over the trimless mounting ring, up to its edge.

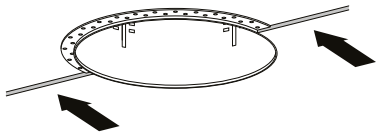

⚠ IMPORTANT

- Ensure luminaire is not installed in mounting ring when plastering. Clean inside of ring afterwards.

- 11 Run mains voltage cable to the hole and connect to the luminaire using an electrical connector (not supplied).

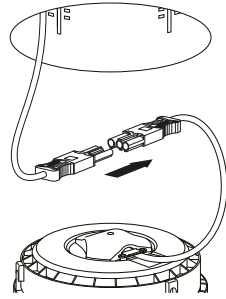

✍ NOTES

- Mains voltage cable should be wired in accordance with international standard IEC 60446:

Earth - Green/Yellow Neutral - Blue Live - Brown

- 12 Insert the transformer through the mounting ring onto the upper surface of the ceiling.

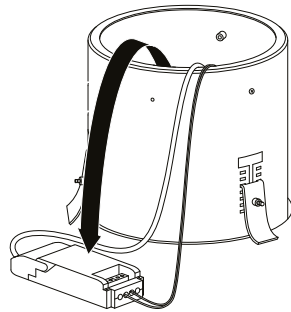

- 13 Insert the luminaire into the mounting ring and push up until it stops.

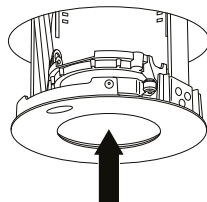

- 14 Rotate the luminaire *clockwise* until it stops and pull down. It should now be locked in place.

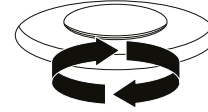

- 15 Ensure that mounting ring studs locate securely in the luminaire mounting hooks, as shown below.

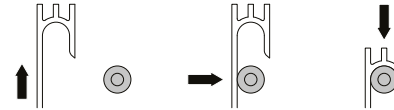

- 16 For multiple fixtures, locate the 'primary' stud on the mounting ring, marked with an arrow and pair with the 'primary' hook on the luminaire.

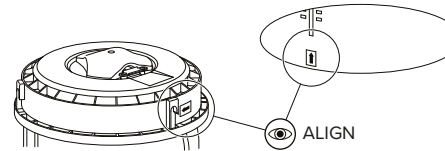

- 17 Align the primary hooks *perpendicular* to a feature such as a wall. This will ensure that all fixtures will align when in their home (neutral) position (advanced version only).

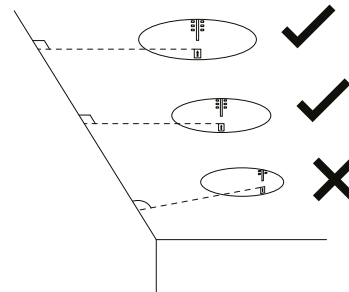

B Lamp Change - QR11

- 1 Disconnect product from mains voltage supply and allow to cool before replacing lamp.

- 2 Push the luminaire up into the mounting ring until it stops.

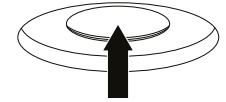

- 3 Rotate the luminaire *anti-clockwise* to unlock it.

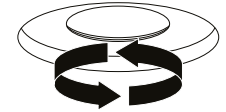

- 4 Remove the luminaire from the mounting ring.

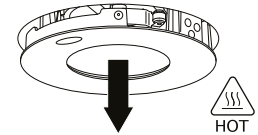

- 5 Unclip the QR11 lamp from the lamp holder and remove.

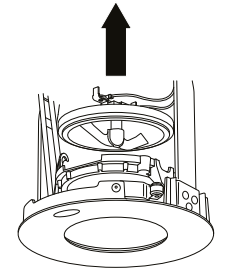

- 6 Unscrew lamp connectors and dispose of lamp correctly. To install a new lamp, reverse this process.

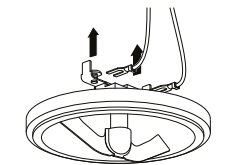

⚠ IMPORTANT

- Ensure lamp connectors are installed securely and screws are tight. Loose connections cause damage.

C Accessory Change - QR111

- 1 Before installing the accessory holder into the DR7 luminaire, you will need to add the accessory into the holder.
- 2 Insert the accessory under one of the tabs on the accessory holder.

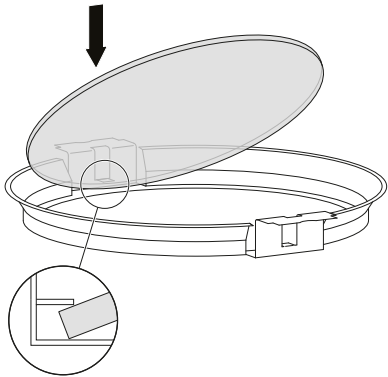

- 3 Insert the opposite side of the accessory under the second tab.

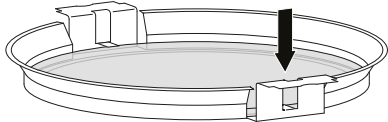

- 4 The accessory should now be held in place securely below the tabs on the holder.



D Accessory Holder Installation

- 1 Before installing the accessory holder, ensure that the luminaire is disconnected from mains power supply and the lamp is unclipped.
- 2 Insert the accessory holder through the DR7's front aperture.

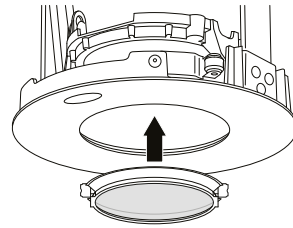

- 3 Insert the accessory holder up through the DR7's lamp holder so that a fixing clip sits in the groove, as shown.

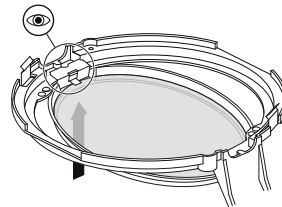

- 4 Repeat this step for the second fixing clip on the opposite side of the accessory holder.

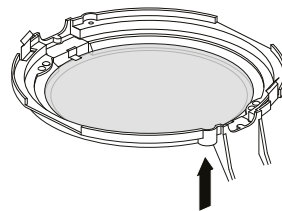

- 5 The accessory holder should now be held securely in place. The lamp can now be installed normally.

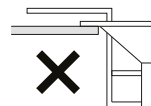
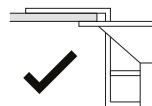

If you have any difficulty installing this product please contact:

Remote Controlled Lighting Ltd (UK) | 42 Riverside Road, London SW17 0BA
+44 (0) 20 8404 2400 | tech@rclighting.com

Remote Controlled Lighting Ltd (Asia) | Unit 13, 8/F, Lai Sun Yuen Long Centre
21-35 Wang Yip Street East, Yuen Long, Hong Kong
T: +852 2310 9733 | F: +852 2310 9723
asia_sales@rclighting.com

Copyright © 2017 Remote Controlled Lighting Ltd. All Rights Reserved.