

Installation Instructions

Remote Controlled Spotlight Type DR8 Mk2

BEFORE YOU START

Read these instructions carefully. For the latest instructions on all our products see www.rclighting.com/downloads

These instructions cover the following installation methods:

- A 3-Circuit Installation
- B 2-Circuit Installation
- C 1-Circuit Installation
- D Monopoint Installation
- E Trough Installation
- F Lamp Change - QR111
- G Lamp Change - HIR111-CE-P
- H Lamp Change - HIT-CE
- I Accessory Change
- J Snoot Installation

If you have any difficulty installing this product please contact:

Remote Controlled Lighting Ltd (UK)
42 Riverside Road, London SW17 0BA
+44 (0) 20 8404 2400
tech@rclighting.com

Remote Controlled Lighting Ltd (Asia)
Unit 13, 8/F, Lai Sun Yuen Long Centre
21-35 Wang Yip Street East,
Yuen Long, Hong Kong
T: +852 2310 9733
F: +852 2310 9723
asia_sales@rclighting.com

Important Safety Information

READ INSTRUCTIONS CAREFULLY BEFORE USING THIS PRODUCT. SAVE INSTRUCTIONS FOR LATER REFERENCE.

PRODUCT IS NOT SUITABLE FOR PHASE DIMMING

Products must be installed by a suitably qualified professional only. Installations must conform to national installation codes and accident prevention regulations.

If using a track adaptor, ensure it is compatible with the track system installed. Failure to do so may result in danger of electric shock and damage to the product.

Ensure electrical rating shown on product label conforms to mains voltage supply.

Do not modify the product in any way. RCL accepts no responsibility for damage caused by modifying this product.

IP20 Product is rated IP20 unless otherwise stated. Install indoors only and away from damp or wet environments.

This symbol indicates the minimum distance to a lighted object and must be observed.

Caution, product will become hot in use. Allow to cool before touching.

Dispose of this product in accordance with WEEE or other national regulations.

Products marked with this symbol are compliant with Class 2 regulations.

A 3-Circuit Track Installation

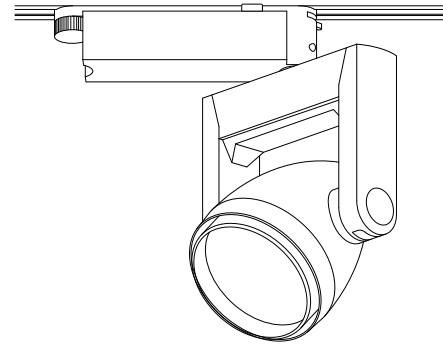

1 Ensure that the track system where the DR8 luminaire is to be installed is compatible with the Eutrac 3-Circuit adaptor.

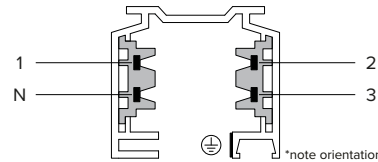

NOTES

- If the spotlight is to be controlled via DMX or DALI, ensure that track system includes Data Bus. See For more information on DMX Installation see DOC-083.

2 To mount the track adaptor into the track system, first check that both the selector knob (A) and the adaptor lock (B) are disengaged, as shown below.



3 When installing the adaptor into the track, ensure that it is orientated correctly. Align the tabs (A) with the slot (B) on the track.

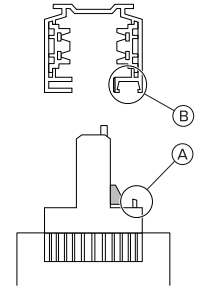

4 Insert the track adaptor into track system. Take care to avoid any fixing screws holding the track onto the ceiling.

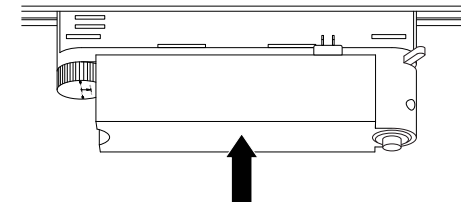

5 Rotate adaptor lock (C) clockwise 90° to connect the adaptor to the neutral circuit.

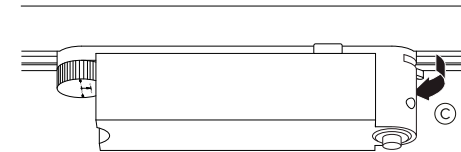

6 Rotate selector knob (D) to the desired circuit position (see section 7).

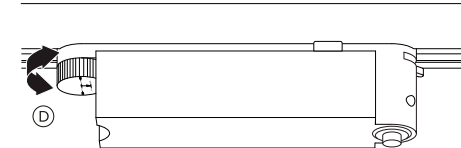

- 7 With the 3-Circuit track adaptor, you can choose which circuit the luminaire is connected to:

Unconnected - The luminaire is not connected to any circuit.

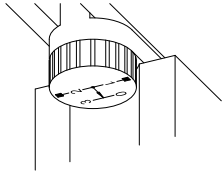

Circuit 1 - From the unconnected position, rotate the knob clockwise 90°.

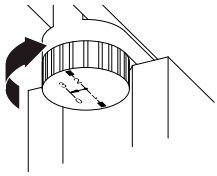

Circuit 2 - From the unconnected position, rotate the knob anticlockwise 90°.

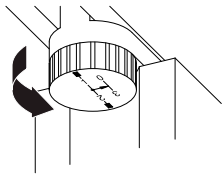

Circuit 3 - From the unconnected position pull knob down ① then rotate anticlockwise 90° ②.

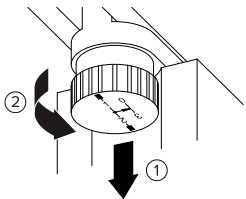

NOTES

- The Eutrac 3-Circuit track adaptor is compatible with a number of different 3-Circuit track systems including Eutrac, Erco & iGuzzini systems. For further options, please contact RCL.

- 8 When installing multiple fixtures, always allow a minimum of 250mm between luminaires.

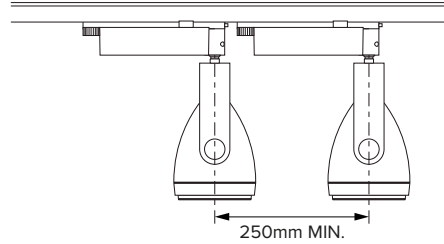

B 2-Circuit Track Installation

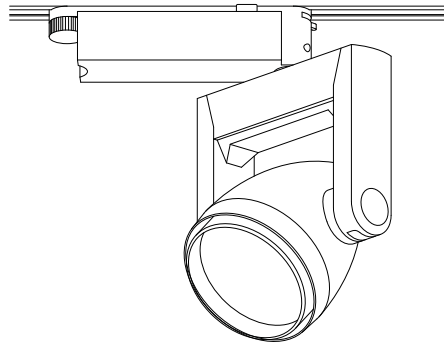

- 1 Ensure that the track system where the DR8 luminaire is to be installed is compatible with the Eutrac 2-Circuit adaptor.

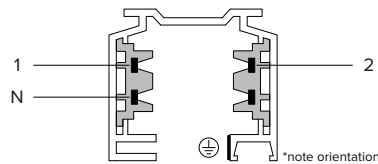

NOTES

- If the spotlight is to be controlled via DMX or DALI, ensure that track system includes Data Bus. See For more information on DMX Installation see DOC-083.

- 2 To mount the track adaptor into the track system, first check that both the selector knob (A) and the adaptor lock (B) are disengaged, as shown below.



- 3 When installing the adaptor into the track, ensure that it is orientated correctly. Align the tabs (A) with the slot (B) on the track.

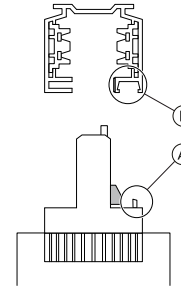

- 4 Insert the track adaptor into track system. Take care to avoid any fixing screws holding the track onto the ceiling.

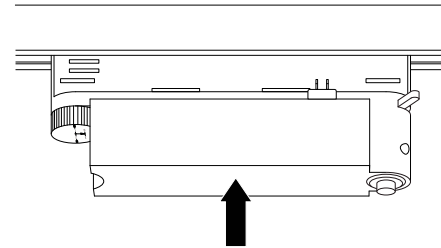

- 5 Rotate adaptor lock (C) clockwise 90° to connect the adaptor to the neutral circuit.

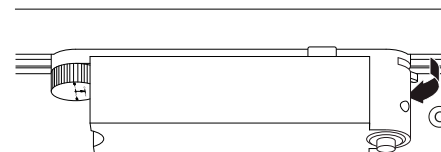

- 6 Rotate selector knob (D) to the desired circuit position (see section 7).

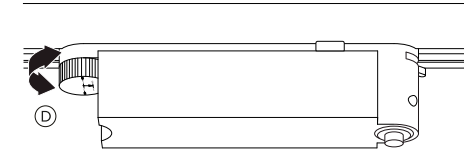

- 7 With the 2-Circuit track adaptor, you can choose which circuit the luminaire is connected to:

Unconnected - The luminaire is not connected to any circuit.

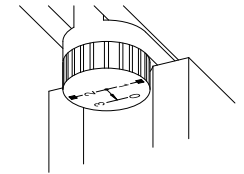

Circuit 1 - From the unconnected position, rotate the knob clockwise 90°.

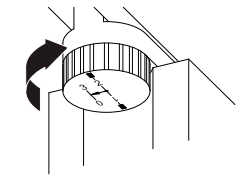

Circuit 2 - From the unconnected position, rotate the knob anticlockwise 90°.

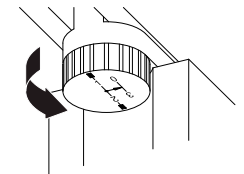

NOTES

- The Eutrac 2-Circuit track adaptor is compatible with a number of different 2-Circuit track systems including Eutrac, Erco & iGuzzini systems. For further options, please contact RCL.

- 8 When installing multiple fixtures, always allow a minimum of 250mm between luminaires.

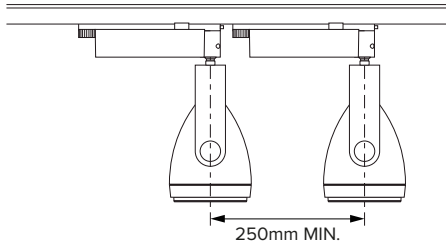

C 1-Circuit Track Installation

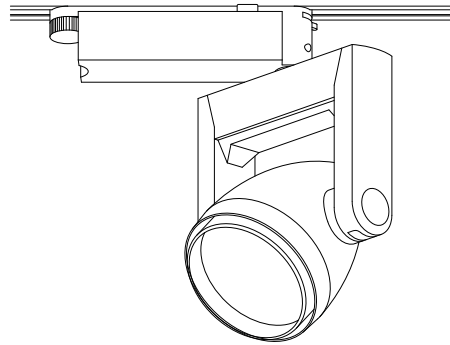

- 1 Ensure that the track system where the DR8 luminaire is to be installed is compatible with the Eutrac 1-Circuit adaptor.

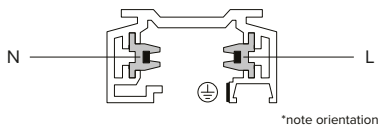

NOTES

- If the spotlight is to be controlled via DMX or DALI, ensure that track system includes Data Bus. See For more information on DMX Installation see DOC-083.

- 2 To mount the track adaptor into the track system, first check that both the selector knob (A) and the adaptor lock (B) are disengaged, as shown below.



- 3 When installing the adaptor into the track, ensure that it is orientated correctly. Align the tabs (A) with the slot (B) on the track.

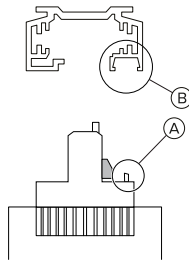

- 4 Insert the track adaptor into track system. Take care to avoid any fixing screws holding the track onto the ceiling.

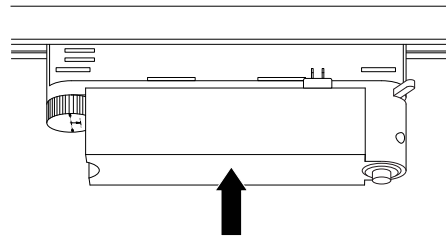

- 5 Rotate adaptor lock (C) clockwise 90° to connect the adaptor to the neutral circuit.

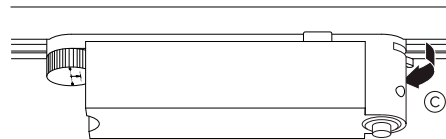

- 6 Rotate selector knob (D) to the desired circuit position (see section 7).

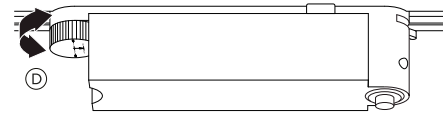

- 7 With the 2-Circuit track adaptor, you can choose which circuit the luminaire is connected to:

Unconnected - The luminaire is not connected to any circuit.

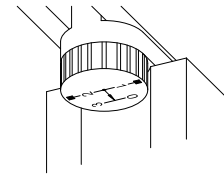

Circuit 1 - From the unconnected position, rotate the knob clockwise 90°.

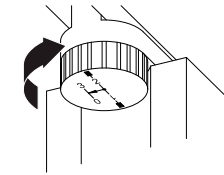

NOTES

- The Eutrac 2-Circuit track adaptor is compatible with a number of different 2-Circuit track systems including Eutrac, Erco & iGuzzini systems. For further options, please contact RCL.

- 8 When installing multiple fixtures, always allow a minimum of 250mm between luminaires.

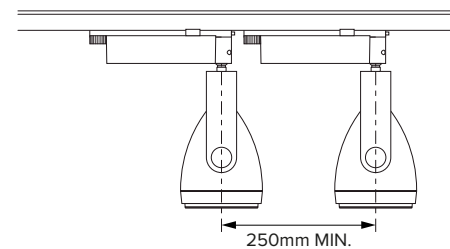

D Monopoint Installation

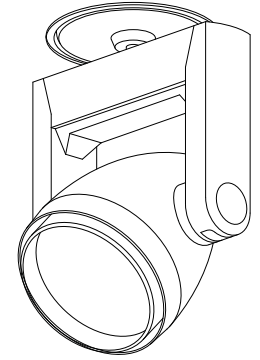

- 1 The monopoint fixture requires a minimum clearance distance of 200mm above and around the mounting point and a ceiling material thickness of between 3-35mm.

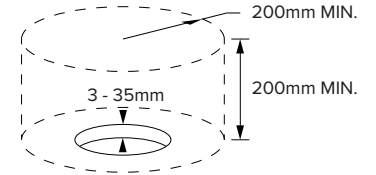

- 2 Mark up the ceiling and cut a circular hole 112-114mm in diameter.

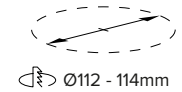

- 3 For multiple installations, ensure a minimum distance of 250mm between mounting points.

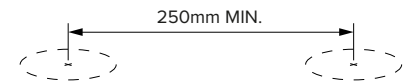

4 Insert the mounting ring into the hole so that it sits flush with the ceiling.

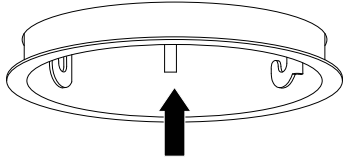

5 Holding the mounting ring in place, insert a fixing clip into a slot on the mounting ring.

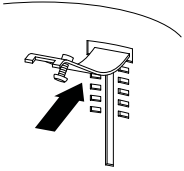

6 Slide the fixing clip down the slot until it hits the ceiling material.

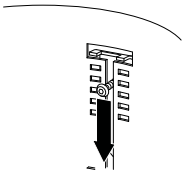

7 Insert fixing studs into mounting ring holes and, using a 2.5mm hex screwdriver, secure the clip in place. Repeat this process for each fixing clip.

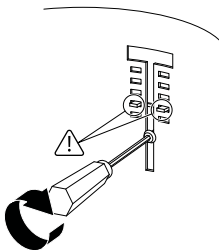

8 Ensure that the luminaire is securely installed, with the fixing clips firmly against the ceiling material.

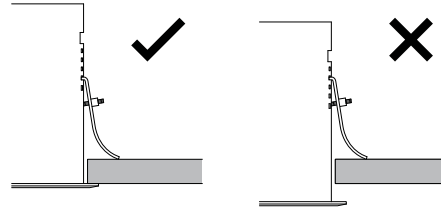

WARNING

- If for any reason the mounting ring cannot be fitted securely, stop the installation and contact RCL.

9 Run mains voltage cable to the hole and connect to the luminaire using an electrical connector (not supplied).

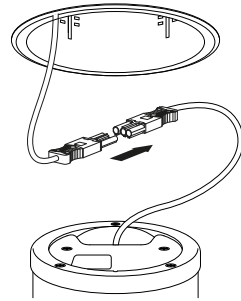

10 For projects that require DMX or DALI control, a 3-way connector will be present on the monopoint head.

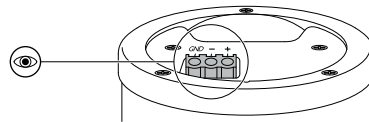

NOTES

- For further instructions on DMX wiring and installation, please refer to DOC-083.
- DMX cable runs must be terminated using a 1W 120 Ω resistor that is connected to the last 3-way connector in the spotlight chain.

11 If DMX or DALI control is specified, run appropriate cable to the mounting hole and connect to the monopoint head using the 3-way connector supplied

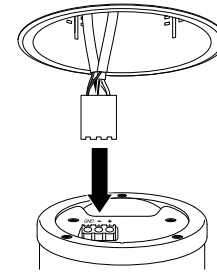

12 Insert the control gear through the mounting ring onto the upper surface of the ceiling.

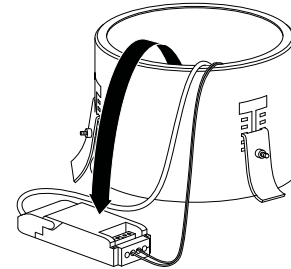

13 Insert DR8 Monopoint head into mounting ring.

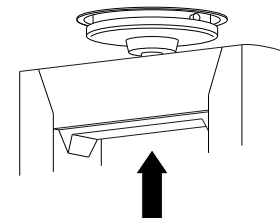

14 Twist spotlight clockwise and pull down gently to lock in place.

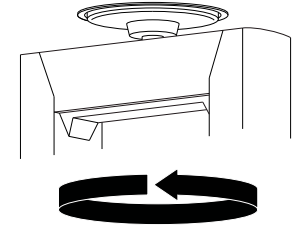

15 Ensure that the monopoint head studs locate securely in the mounting ring hooks, as shown below.

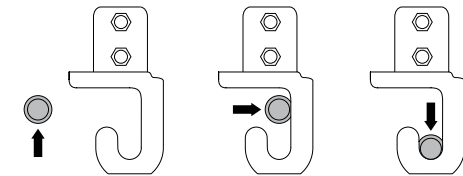

16 For multiple fixtures, Align primary hooks (denoted by a directional arrow) perpendicular to a feature such as a wall or trough edge to ensure all fixtures will align.

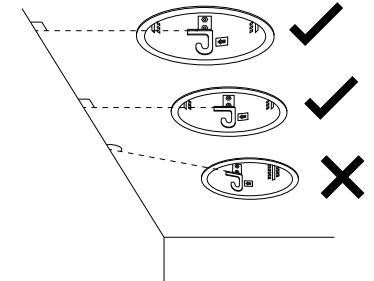

E Trough Installation

- 1 If installing the DR8 luminaire into a trough, ensure a minimum internal trough width of 220mm.

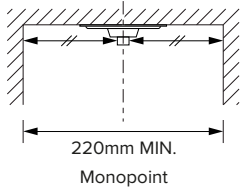
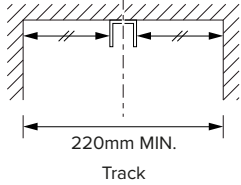

NOTES

- The track system or monopoints should be mounted centrally within the trough.

- 2 To prevent overheating, troughs must be suitably ventilated. Holes or slots with a minimum area of 600mm² should be included at 500mm intervals along the trough length.

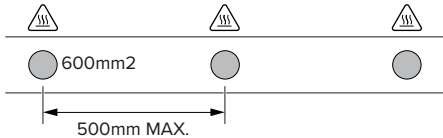

IMPORTANT

- When mounting luminaires in troughs, always observe the minimum distance to a lighted object, as indicated on the fixture.

For more information regarding correct trough installation, please contact RCL directly.

F Lamp Change - QR111

- 1 Disconnect product from mains voltage supply and allow to cool before replacing lamp.

Twist DR8 bezel anti-clockwise and remove from luminaire.

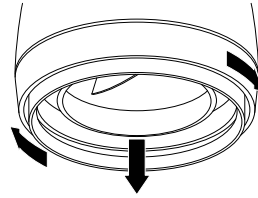

- 2 Unscrew lamp screws and disconnect the lamp connectors from the lamp.

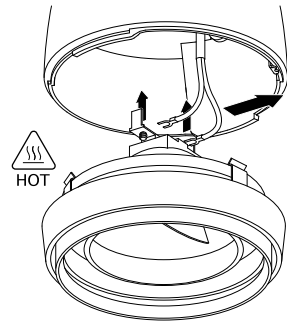

- 3 Unclip accessory holder and dispose of lamp correctly. To install a new lamp, reverse this process making certain lamp connectors are secured tightly to ensure a good connection and to avoid damage.

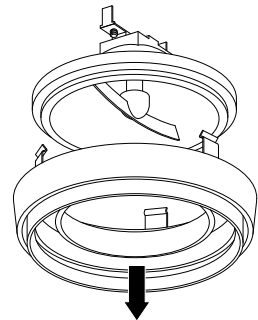

G Lamp Change - HIR111-CE-P

- 1 Disconnect product from mains voltage supply and allow to cool before replacing lamp.

- 2 Twist DR8 bezel anti-clockwise and remove from luminaire.

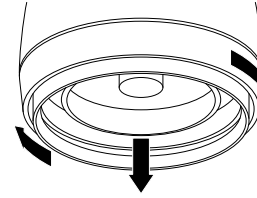

- 3 Twist the lamp anti-clockwise to disconnect.

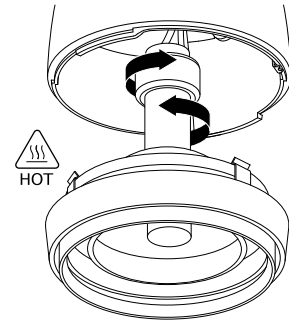

- 4 Unclip accessory holder and dispose of lamp correctly. To install a new lamp, reverse this process ensuring lamp is secured tightly.

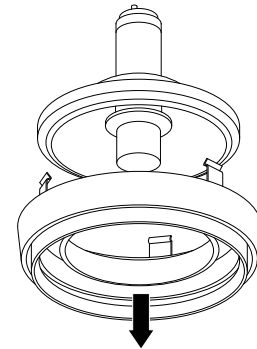

H Lamp Change - HIT-CE

- 1 Disconnect product from mains voltage supply and allow to cool before replacing lamp.

- 2 Twist DR8 bezel anti-clockwise and remove from luminaire.

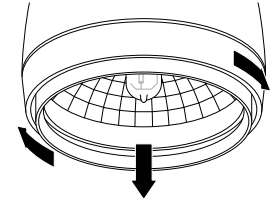

- 3 Remove the lamp from it's socket. To install a new lamp, reverse this process.

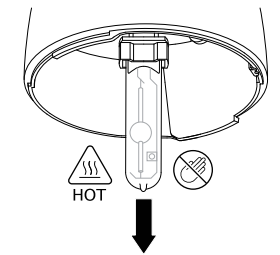

IMPORTANT

- Avoid contact with skin when handling HIT-CE lamps. Wear gloves where possible.

Accessory Change

- 1 Twist DR8 bezel anti-clockwise and remove from luminaire. If necessary, disconnect the lamp.

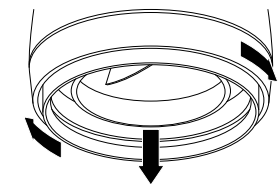

2 Unclip the bezel ring from the accessory holder.

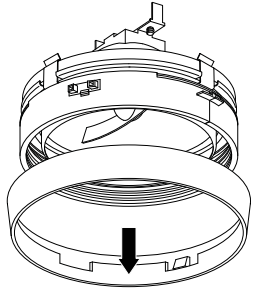

3 The accessory holder can hold up to two lenses, depending on the lamp type.

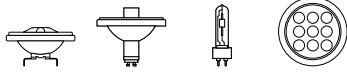

Slot 1	✗	✗	Safety Glass	✓
Slot 2	✓	✓		✓

4 Separate the two accessory holder sections.

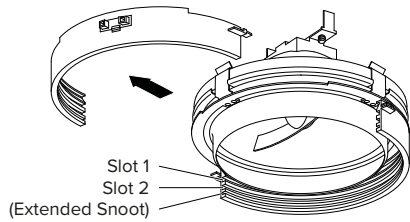

5 Insert a lens into the accessory holder and reverse the process to reassemble the bezel and reattach to the DR8 spotlight.

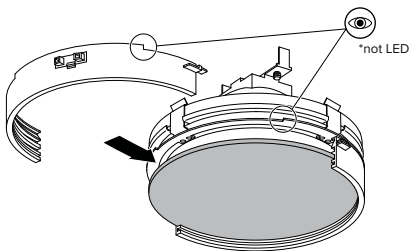

J Snoot Installation

- 1 Remove the accessory holder assembly from the luminaire, as shown in section G, parts 1 & 2.
- 2 Insert the lamp holder/lamp reflector into one half of the accessory ring, as shown.

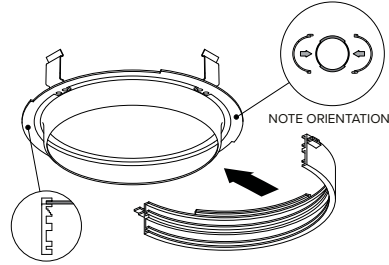

- 3 Insert the snoot into bottom slot of the accessory ring, as shown and bring the two halves of the ring together.

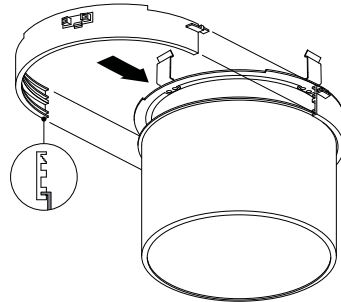

- 4 Insert the bezel ring over the snoot and clip into place over the accessory ring to lock the assembly together. Reattach the assembly to the DR8 spotlight.

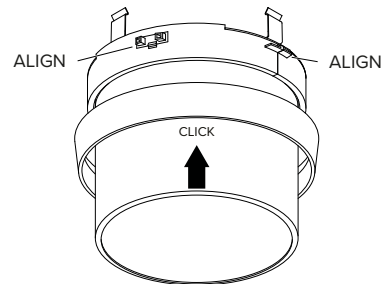

If you have any difficulty installing this product please contact:

Remote Controlled Lighting Ltd (UK) | 42 Riverside Road, London SW17 0BA
+44 (0) 20 8404 2400 | tech@rclighting.com

Remote Controlled Lighting Ltd (Asia) | Unit 13, 8/F, Lai Sun Yuen Long Centre
21-35 Wang Yip Street East, Yuen Long, Hong Kong
T: +852 2310 9733 | F: +852 2310 9723
asia_sales@rclighting.com

Copyright © 2017 Remote Controlled Lighting Ltd. All Rights Reserved.