

Installation Instructions

Remote Controlled Spotlight Type DRX7 for Ultra Airtight IC Housing Installation

BEFORE YOU START

Read these instructions carefully. For the latest instructions on all our products see www.rclighting.com/downloads

These instructions cover the following installation methods:

- A IC Housing Installation
- B Wiring Instructions
- C Mounting Ring Installation
- D Accessory Installation

IMPORTANT SAFETY INFORMATION CONSIGNES DE SÉCURITÉ IMPORTANTES

- A Read all instructions.
Lire toutes les instructions.
- B Do not install any luminaire assembly closer than 6 inches from any curtain, or similar combustible material.
N'installez aucun luminaire à moins de 6 pouces d'un rideau ou d'un matériau combustible similaire.

SAVE THESE INSTRUCTIONS CONSERVEZ CES INSTRUCTIONS

PRODUCT IS NOT SUITABLE FOR PHASE DIMMING

THIS PRODUCT MUST BE INSTALLED IN ACCORDANCE WITH THE APPLICABLE INSTALLATION CODE BY A PERSON FAMILIAR WITH

- THE CONSTRUCTION AND OPERATION OF THE PRODUCT AND THE HAZARDS INVOLVED.
- Ensure electrical rating shown on product label conforms to input voltage supply.
 - Do not modify the product in any way. RCL accepts no responsibility for damage caused by modifying this product.
 - Product is rated for dry or damp locations only.
 - This symbol indicates the minimum distance to a lighted object and must be observed.
 - Caution, product will become hot in use. Allow to cool before touching. Ambient temperatures should not exceed 40°C/104°F in desired mounting location.
 - Dispose of this product in accordance with WEEE or other national regulations.
 - Products marked with this symbol are ETL Certified and compliant with UL1598 and UL8750 standards.

IC Housing Installation

1 Before you start, check that you have all the parts listed below. Only 1 part of either (B) or (C) should be included.

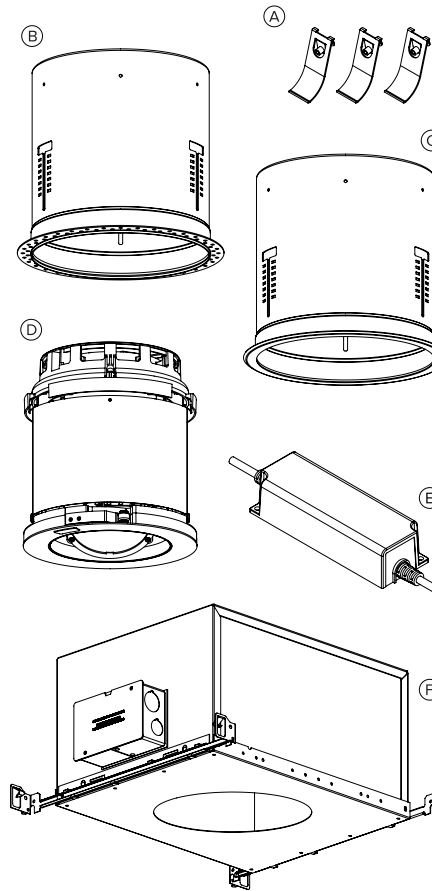

A - Long Fixing Clips (x3); B - Trimless Mounting Ring; C - Standard Mounting Ring; D - DRX7 Luminaire; E - Power Supply; F - Ultra Airtight IC Box Assembly

IMPORTANT

- IC Housing must only be installed in surfaces of sound structural integrity
- IC Housing assembly should be installed in dry or damp locations only

2 DRX7 is rated for use in insulated ceilings with zero clearance to building members.

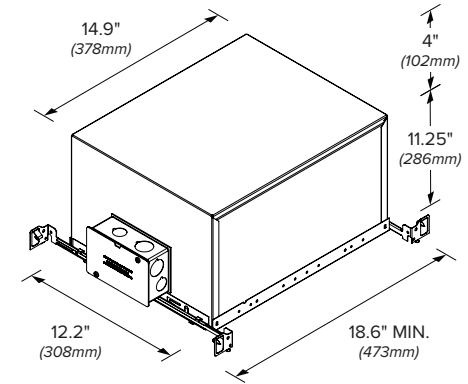

3 DRX7 IC Housing contains bar hangers suitable to fit between 16" spaced joists and 24" spaced joists. To assemble, feed the two mating parts together through the mounting brackets on the side of the plaster frame.



4 With the IC Housing raised into the ceiling cavity, extend the bar hangers to meet each joist ensuring that the foot flange is flush with the under-side of the joist.

5 Examine your joist material. If the joist is wood, hammer in 5-point nail support and two wood screws or nails to fix the hanger arm in position. If the joist is metal, use suitable screws.

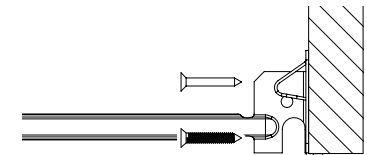

6 For multiple installations, ensure a *minimum* distance of 4" (102mm) between IC Housing assemblies.

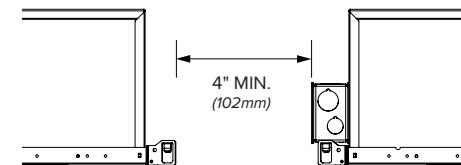

B Wiring Instructions

- 1 Insert the power supply through the plaster mounting frame and fasten to the inside cover of the junction box using two 8/32" hex nuts.

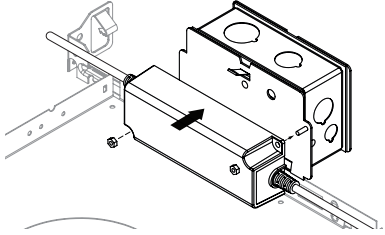

- 2 Feed the power supply flying lead into the junction box via the hole provided.

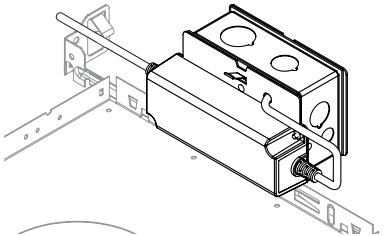

- 3 Bring field wiring in through the provided knockouts in the junction box.

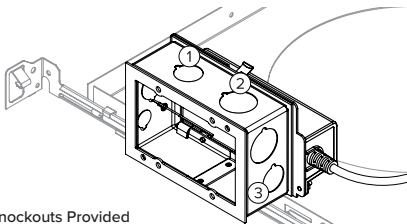

Knockouts Provided

- ① 1/2" Knockout (x2);
- ② 3/4" Knockout (x2);
- ③ 9/16" Knockout (x1) - for low voltage cable (installation codes permitting)

⚠ CAUTION

- Leave enough of a service loop of wire to inspect and repair the splices and power supply via the aperture of the fixture after the ceiling is closed.

✎ NOTES

- Input wiring color code:
Hot - Brown
Neutral - Blue
Ground - Green (insulated)
- 4 Fasten outer junction box cover to the gasket using two 8-32" self-tapping screws.

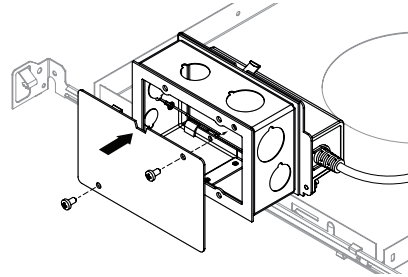

C Mounting Ring Installation

- 1 With the IC enclosure installed in the ceiling cavity, install the ceiling material up to the plaster frame.

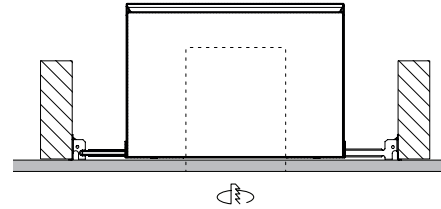

⚠ IMPORTANT

- If installing a DRX7 Trimless fixture, ensure that trimless mounting ring is installed in the IC enclosure (C3 - C7) before plastering - see below.
- Ensure luminaire is not installed in the mounting ring when plastering. Clean inside of ring afterwards

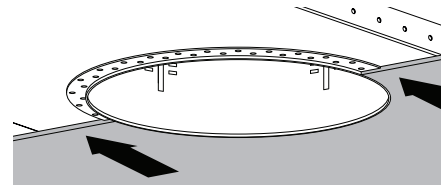

- 2 Mark up ceiling and cut a circular hole $\varnothing 7.67"$ (195mm) in diameter.

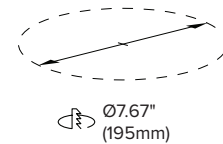

- 3 Insert the mounting ring into the plaster frame hole and push up so that it sits flush with the ceiling material.

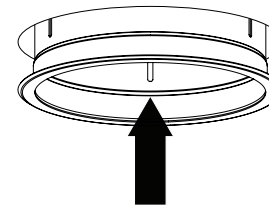

- 4 Holding the mounting ring in place, insert a fixing clip into a slot on the mounting ring, then slide it down the slot until it hits the ceiling material.

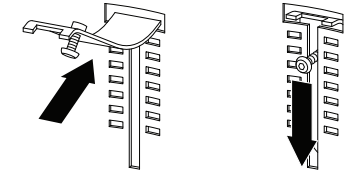

- 5 These guidelines can be used to determine the most appropriate slots to use for varying ceiling thicknesses.

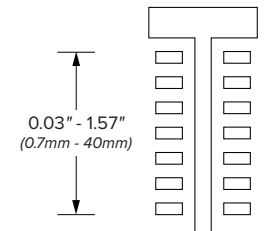

- 6 Insert fixing studs into mounting ring holes and, using a screwdriver, secure the clip in place. Repeat this process for each fixing clip.

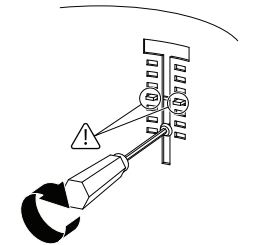

- 7 Ensure that the luminaire is securely installed, with the fixing clips firmly against the plaster frame.

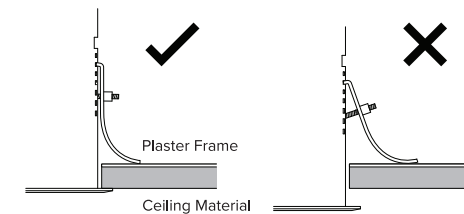

⚠ WARNING

- If for any reason the mounting ring cannot be fitted securely, stop the installation and contact RCL.

8 Run low voltage cable through the hole at top of mounting ring and connect to the luminaire using the right angled connector jack (supplied).

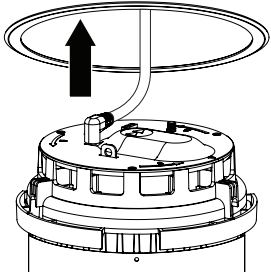

9 Insert the luminaire into the mounting ring and push up until it stops.

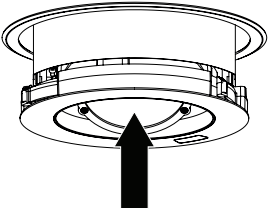

10 Rotate the luminaire *clockwise* until it stops and pull down. It should now be locked in place.

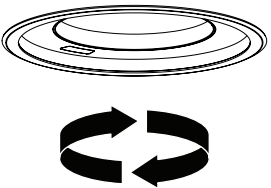

11 Ensure that mounting ring studs locate securely in the luminaire mounting hooks, as shown below.

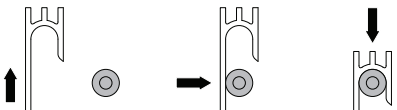

12 For multiple fixtures, locate the 'primary' stud on the mounting ring, marked with an arrow and pair with the 'primary' hook on the luminaire.

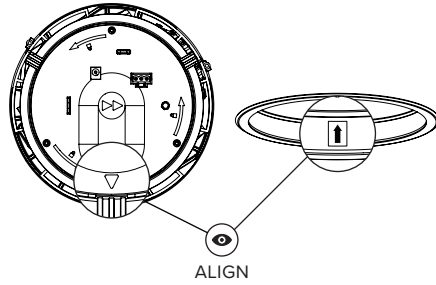

13 Align the primary hooks *perpendicular* to a feature such as a wall. This will ensure that all fixtures will align when in their home (neutral) position (advanced version only).

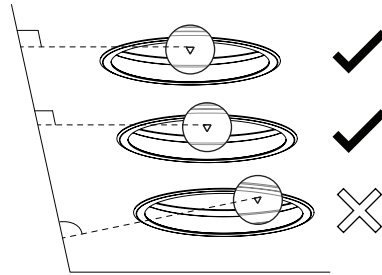

D Accessory Installation

1 Before installing the accessory holder into the DRX7 luminaire, you will need to add the accessory into the holder.

2 Insert the accessory into the reverse of the accessory holder.

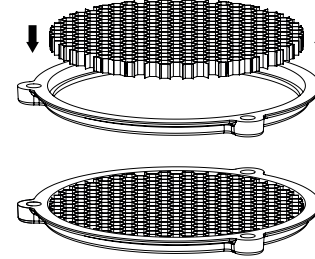

3 Insert the accessory holder up through the DRX7 face plate and magnetically attach to the optic holder.

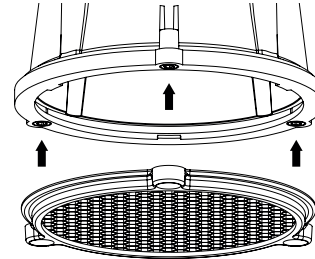



If you have any difficulty installing this product please contact:

Remote Controlled Lighting Ltd (UK) | 42 Riverside Road, London SW17 0BA
+44 (0) 20 8404 2400 | tech@rclighting.com

Copyright © 2021 Remote Controlled Lighting Ltd. All Rights Reserved.